

Nonarc**THERMAL RELAY**

Part No.

JR28 (LR2)**FEATURE**

- Three phase bimetallic strip , trip class 10A
- With automatic reset
- Ambient temperature compensation
- Phase monitoring
- Visual indicators
- Used for circuit of AC 50/60Hz, 690V
- As per standard GB14048.4 & IEC60947-4-1

TECHNICAL DATA

Model	JR28-D13	JR28-D23	JR28-D33	JR28-D43		
Rated current	25	40	93	140		
Rated insulation voltage	690	690	690	690		
Loss phase monitoring	√	√	√	√		
Manual/automatic reset	√	√	√	√		
Ambient temperature compensation	√	√	√	√		
Tripping indicators	√	√	√	√		
Test button	√	√	√	√		
Stop button	√	√	√	√		
Installation	Plug-in	Plug-in	Plug-in	Plug-in		
Auxiliary contact	1NO+1NC	1NO+1NC	1NO+1NC	1NO+1NC		
AC-15 220V Rated current (A)	2.73	2.73	2.73	2.73		
AC-15 380V Rated current (A)	1.58	1.58	1.58	1.58		
DC-15 220V Rated current (A)	0.2	0.2	0.2	0.2		
Wire cross-section (mm ²)	Main circuit	Single core	1~4	4~10	4~35	4~35
		Screw	M4	M4	M4	M4
	Auxiliary circuit	Single core	0.5~2.5	0.5~2.5	0.5~2.5	0.5~2.5
		Screw	M3.5	M3.5	M3.5	M3.5

ORDERING INFORMATION

Model	Rated current (A)	Fuse protector		Matched AC contact model
		Type "1"	Type "2"	
D1301	0.1~0.16	0.25	2	CJX-09 CJX-12 CJX-18 CJX-25
D1302	0.16~0.25	0.5	2	
D1303	0.25~0.4	1	2	
D1304	0.25~0.63	1	2	
D1305	0.63~1	2	4	
D1306	1~1.6	2	4	
D1307	1.6~2.5	4	6	
D1308	2.5~4	6	10	
D1310	4~6	8	16	
D1312	5.5~8	12	20	
D1314	7~10	12	20	
D1316	9~13	16	25	
D1321	12~18	20	35	
D1322	17~25	25	50	
D2353	23~32	80	63	CJX2-32
D2355	30~40	40	80	
D3322	17~25	40	63	CJX2-40 CJX2-50 CJX2-65 CJX2-80 CJX2-95
D3353	23~32	40	63	
D3355	30~40	40	100	
D3357	37~50	63	100	
D3359	58~65	63	100	
D3361	55~70	80	125	
D3363	63~80	80	125	
D3365	80~93	100	160	
D4365	80~104	125	200	CJX2-95 CJX2-115 CJX2-150
D4367	95~120	125	224	
D4369	110~140	160	250	
D5369	90~150	160	250	

DIMENSIONS (mm)

JR28(LR2)-D13 Plug in

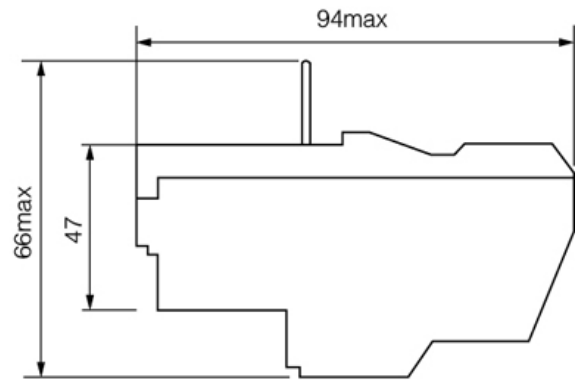
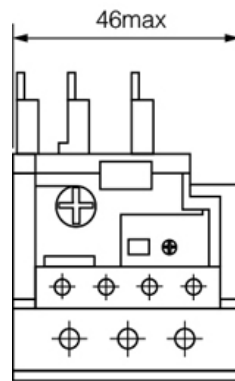

JR28(LR2)-D23 Plug in

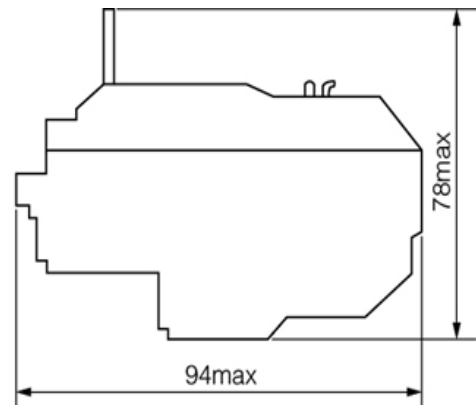
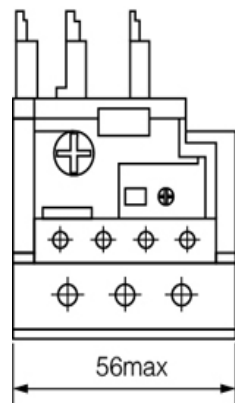

JR28(LR2)-D33 Plug in

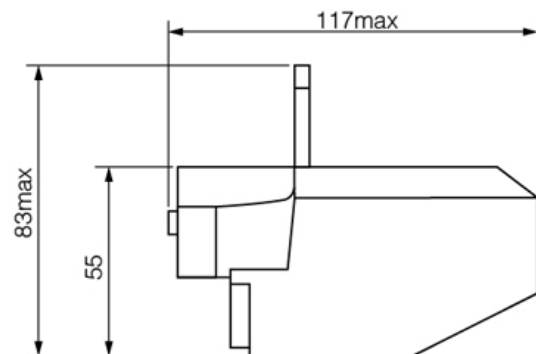
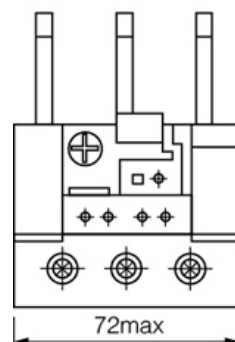

JR28(LR2)-D13 Independent type

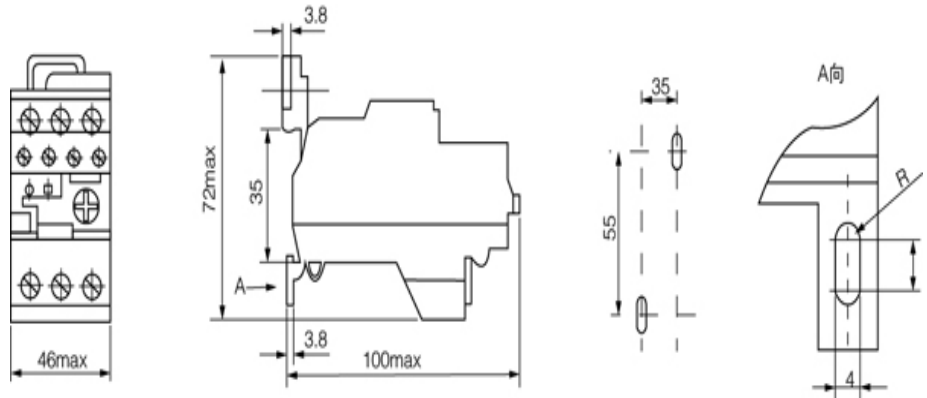

JR28(LR2)-D23 Independent type

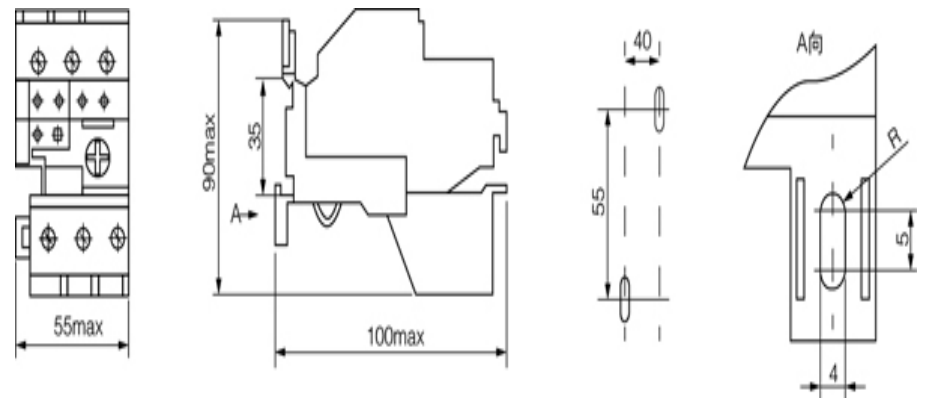

JR28(LR2)-D33 Independent type

